

Wired Controller Operation & Installation Manual

YR-E17

CONTENT

Parts and Functions.....	1
Operation.....	9
Wired Controller Wiring Instruction.....	46

- Please read this operation manual before using the air conditioner.
- Please keep this manual carefully and safely.

Parts and Functions

Interface Display

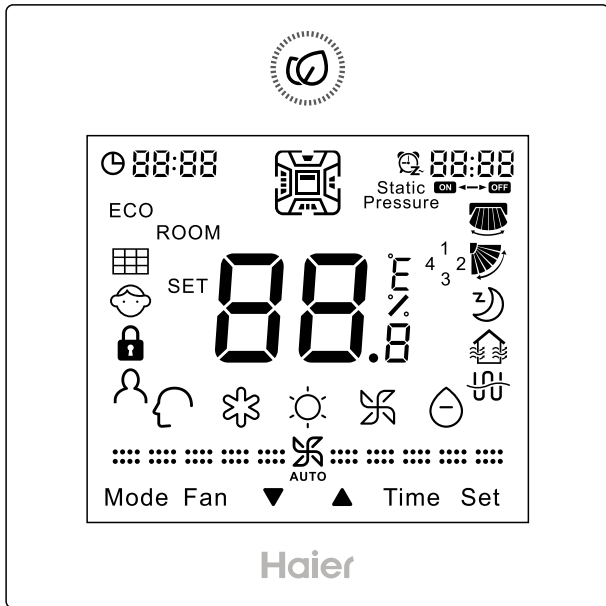

Parts and Functions

Key



ON/OFF



Adjusting key for temperature, clock, timer, sleeping adjustment, temp. compensation and energy saving;
Inquiring key for detail parameter and malfunction inquiry;
Switching key for function switch.

The adjusting accuracy of temperature is 0.5°C (1°F). If energy saving mode is not set, the adjusting range is from 16°C (60°F) to 30°C (86°F). If energy saving mode is set, the lowest temperature limit of cooling/dry and the highest temperature limit of heating are decided by the setting of the chip, the default cooling/dry temperature is 23°C (74°F), and the default heating temperature is 26°C (78°F).

Note:

- If the dip switch Sw2 is “on”, it displays the ambient temp., as well as when powered off. From power off to power on, mode switching and set temp. adjustment, it flashes to display SET icon and statically displays the set temp.. And then statically displays the ambient temp. and ROOM icon after 3 seconds. In energy saving mode and temp. compensation mode, the adjusting step is 1°C (1°F) a time.

Parts and Functions

- If using Fresh Air unit, set temp. cannot be adjusted. If there is no Central/Lock set, the temp. will be fixed at 18°C (64°F) in cooling and 22°C (72°F) in heating. The Up/Down key will not display in normal state, but will display and valid in timer setting, function selection, unit shift in malfunction inquiry, parameter shift in parameter check, unit No. setting, sleeping time adjustment, etc.



24-hour, press ▼ once to minus one minute. Keep pressing, minus 2 minutes in 1 second's pressing, then 10 minutes in 5 seconds. The time will keep decreasing at the pace of 10 minutes a time in 10 seconds. Vice-versa. Press SET to confirm or it will turn back to the previous state automatically in 10s.





Mode

Press this key to execute mode switch. For detailed information, please refer to mode setting.





Note: If using Fresh Air unit, default 3 modes will circulate from cooling→heating→fan→cooling.

Parts and Functions







Fan

Pressing this key, fan speed will be changed in sequence as follows:  (Low) →  (Medium) →  (High) →  (Auto) →  (Low)





Note: Auto fan will be changed in sequence as follows:

 →  →  → 

Pressing this key, fan speed will be changed in sequence as follows (Only valid for parts of models):

 (Breeze) →  (Low) →  (Medium) →  (High) →  (Super) →  (Auto) →  (Breeze)

Auto fan circulation:

 (Breeze) →  (Low) →  (Medium) →  (High) →  (Super)

There is no auto fan in fan mode; The fan icon will flash when adjusting the fan speed. It will statically display after the adjustment.

Parts and Functions

Note: If using Fresh Air unit, fan will be in auto fan and cannot be adjusted. If press FAN key, fan icon and FFFF on the top-right corner will flash, prompting fan speed cannot be adjusted, and will statically display after 3s. Fresh Air unit fan speed will be controlled automatically by indoor unit and wired controller will always display auto fan.









Time

Timer ON, Timer OFF, Timer ON/OFF.











Set

Press this key to enter function circulation. If it is the four-way cassette model, press Set key for 5s to enter function circulation.



1.Press ▼ to select the functions in sequence as follows:

 (Only when Left/Right swing is valid) →  (Only when Up/Down swing is valid) →  →  (ventilation function) →  (reserved function) →  (When it's time for filter cleaning, this icon will involve in circulation) →  (the second 8 of 88.8 in the temp. display area displaying A, only valid for part of models) →  (the second 8 of 88.8 in the temp. display area displaying B, only valid for part of models) →  (motion sensing, only valid for part of models) → 10°C heating function (this function only works in the heating mode, only valid for part of models) → health airflow up (Only valid for part of models) → health airflow down (Only valid for part of models)

Parts and Functions









2. Press  to select the functions in sequence as follows:
health airflow down (Only valid for part of models) → health
airflow up (Only valid for part of models) → 10°C heating
function (this function only works in the heating mode, only
valid for part of models) →  (motion sensing, only valid
for part of models) →  (the second 8 of 88.8 in the temp.
display area displaying B, only valid for part of models) →  (the second 8 of 88.8 in the temp. display area displaying
A, only valid for part of models) →  (When it's time for filter
cleaning, this icon will involve in circulation) →  (reserved
function) →  (ventilation function) →  →  (Only when
Up/Down swing is valid) →  (Only when Left/Right swing is
valid)

3. Press **Set** to confirm function selected. If there is function
selected, press **Set** can cancel this function.















Note: The Left/Right swing  is valid only after the dip switch
is set, the filter icon  is shown only after the filter requires
cleaning.

Parts and Functions

Icon

 88:88	Clock; Parameter setting/inquiry; Malfunction display; Mode setting.
 88:88 ON ← → OFF	Timer ON/OFF: Sleeping; Parameter setting/inquiry; Malfunction display.
ROOM SET 88.0 %RH	ROOM/SET temp. and humidity display, each step is 0.5°C (1°F) . For example, if the temp. is 25°C (77°F), it will display 25.0°C (77°F). Humidity display function is reserved.
ECO	Energy Saving, This icon will be displayed only when energy saving function is set.
	Filter Cleaning.
	Child Lock. This icon will be displayed only when child lock function is set.
	Lock/ Central
	Motion Sensing (Only valid for part of models).
	Left/Right Swing. This icon is displayed in swing mode; no display without swing mode.
	Up/Down Swing. This icon is displayed in swing mode; no display without swing mode.

Parts and Functions

	Sleeping. This icon is displayed when setting the sleeping, and left time of sleeping is displayed by 88:88 		
	Heat Reclaim Ventilation, This icon is displayed when setting the heat reclaim ventilation.		
	Electrical Heating. This icon will display when electrical heating is set on DC wired controller.		
	Intelligent Mode.		
	Cooling Mode.		Heating Mode.
	Fan Mode.		Dry Mode.
:::  :::		Breeze Fan Speed (Only valid for part of models)	
::: :::  ::: :::		Low Fan Speed.	
::: ::: :::  ::: ::: :::		Medium Fan Speed.	
::: ::: ::: :::  ::: ::: ::: :::		High Fan Speed.	
::: ::: ::: ::: :::  ::: ::: ::: ::: :::		Super Fan Speed (Only valid for part of models)	
<p>If the fan speed is set in auto fan, it will change in the following sequence: Breeze(Only valid for part of models) →Low→Medium→High→Super (Only valid for part of models), AUTO icon will display simultaneously.</p>			

Operation

Dip Switch Interpretation (for AC)

DIP switch	On/Off station	Function	Default setting
Sw1	On	Slave wired controller	Off
	Off	Master wired controller	
Sw2	On	Ambient temp. display on	Off
	Off	Ambient temp. display off	
Sw3	On	Collect ambient temp. from PCB of indoor	Off
	Off	Collect ambient Temp. from wired controller	
Sw4	On	Non-volatile memory invalid	Off
	Off	Non-volatile memory valid	
Sw5	On	Old protocol	Off
	Off	Selfadaption	
Sw6	On	reserved	Off
	Off	reserved	
Sw7	On	Model with Up/Down and Left/Right swing	Off
	Off	Model with Up/Down swing	
Sw8	On	Fresh Air unit	Off
	Off	General unit	

Operation

Difference between the Function of the Master Wired Controller and Slave Wired Controller

Comparison item	Master wired controller	Slave wired controller
Function	All functions are available	1. ON/OFF, Mode, Fan Speed, Temp. Setting, Swing, Energy Saving, Clock function, Heat Reclaim Ventilation function, Mode Setting, Screen Saving and Child Lock are available 2. Cancel the filter cleaning icon 3. Look up the detailed parameter and malfunction code

Initialization

(1) The wired controller will display all the icons after powering on or reset, then get into the initializing process. The controller will display in sequence as follows: 88:88 (the top-left corner) \rightarrow 88:88 (the top-right corner) \rightarrow 88.8 \rightarrow 88:88 (the top-left corner), the green LED flashes all the time until the initialization ends.

Operation

(2) If the wired controller can't be communicated with the indoor PCB normally after powering on, the initialization will be finished in 4 minutes, and then the communication malfunction can be checked from the malfunction inquiry function.

Screen Saving

(1) In the state of off and non screen saving, keep pressing Time and ▼ for 5s to set screen saving time, which will be shown after the top-right colon 88 statically. Press Up/Down key to adjust screen saving time and press Set key to confirm.

(2) Screen saving time should be 0s(backlight always on), 15s, 30s, 60s, default value is 15s. If it is not the first time of entering, it will display the screen saving time adjusted last time.

(3) In the process of changing screen saving time, press ON/OFF key to quit screen saving time setting function, it will recover to screen saving time before adjustment and start-up the unit.



Note:

When controlling Fresh Air unit, the controller main interface will not display Up/Down key in normal state. When in screen saving setting, press Time key first to display Up/Down key at the main interface, and then press together Time and Down key to enter screen saving time setting.

Operation

Clock Function

(1) 24-hour system is used, and at first time of powering on, it will display default 12:00.

(2) When first powering on wired controller,  12:00 will be displayed on the wired controller interface, clock time can be adjusted within 10s. At the same time, clock icon  and minute-place of time will flash, meaning the current time can be adjusted. Press Up/Down key to adjust minute-place with flashing of clock icon and no flashing of minute-place. Press Time key to shift to hour-place, and then press Up/Down key to adjust hour-place with flashing of clock icon and no flashing of hour-place. After adjustment, clock icon and hour-place will flash and press Set key to confirm and clock icon and time will display statically.

Operation

(3) Press Time key for 5s to enter clock setting function. It will show  12:00 after first powering on (if not first time of powering on, clock time is the memorized time), with clock icon and minute-place flashing, meaning current time can be adjusted. Press Up/Down key to adjust minute-place with flashing of clock icon and no flashing of minute-place. Press Time key to shift to hour-place, and then press Up/Down key to adjust hour-place with flashing of clock icon and no flashing of hour-place. After adjustment, clock icon and hour-place will flash and press Set key to confirm and clock icon and time will display statically.

(4) Clock time adjustment: when adjusting time, press ▼ one time to reduce one minute/hour while press ▲ one time to add one minute/hour. Keep pressing ▼ or ▲ key to accelerate time adjustment, with 2 times/s change after 1 s, 10 times/s change after 5s. After 10s, it will change by 10 minutes and frequency is 10 times/s.

(5) In the process of time adjustment, if there is no operation for 10s, it will quit and restore previous state.

(6) In the process of time adjustment, press ON/OFF key to quit clock setting function and execute turning on/off operation at the same time.

Operation

(7) When setting timer or sleeping function, clock time cannot be adjusted. If press Time key for 5s to enter clock adjustment, clock icon and clock time will flash indicating time cannot be adjusted.

Timer Function

(1) Timer mode setting: Timer ON, Timer OFF, Timer ON/OFF.

(2) Default: Timer ON is  8:00, Timer OFF is  12:00.

(3) Precision: The time precision is 1 minute. Timer clock is based on the current clock time; the adjustment is the same as clock time.

(4) Screen display: The icon is set to be presented on the top-right of the screen.

(5) Relation to the  (ON/OFF): The ON/OFF button has no affection on timer setting. Under power off state, the Time key is valid.

(6) Timer display:



Timer ON:

Press Time key, it displays default  8:00 for the first time (previous setting will be displayed if there is setting before).



Operation

Then hour position and “ON” are flashing. Press ▼▲ to adjust the timer, minus/add 1 hour a time. Keep pressing to accelerate the adjusting speed. Press Time key a second time and then the minute position and “ON” are flashing. Press Set to confirm the setting, the setting time is displayed and “ON” will not flash. If there is no input for 10s, this setting will be cancelled and the timer will come back to the previous state.

Timer OFF:



Press Time key, it displays default  8:00  for the first time (previous setting will be displayed if there is setting before).

Then hour position and “ON” are flashing; Press Time key again, the minute position and “ON” are flashing; Press



Time key again, it displays default  12:00  for the first time (previous setting will be displayed if there is setting before).

Then the hour position and “OFF” are flashing. Press ▼▲ to adjust the timer, minus/add 1 hour a time. Keep pressing to accelerate the adjusting speed; Press Time key again, the minute position and “OFF” are flashing. Press Set to confirm the setting, the setting time is displayed and “OFF” will not flash. If there is no input for 10s, this setting will be cancelled and the timer will come back to the previous state.

Timer ON/OFF:

Press Time key, it displays default  8:00  for the first time (previous setting will be displayed if there is setting before).

Operation

Then hour position and “ON” are flashing; Press Time key again, the minute position and “ON” are flashing; Press Time key again, it displays default  12:00 for the first time (previous setting will be displayed if there is setting before). Then the hour position and “OFF” are flashing; Press Time key again, the minute position and “OFF” are flashing; Press Time key again, it displays default  8:00 for the first time (previous setting will be displayed if there is setting before). Then the hour position and “ON” are flashing. Press ▼▲ to adjust the timer, minus/add 1 hour a time. Keep pressing to accelerate the adjusting speed; Press Time key again, the minute position and “ON” are flashing; Press Time key again, it displays default  12:00 for the first time (previous setting will be displayed if there is setting before). Then the hour and “OFF” are flashing. Press ▼▲ to adjust the timer, minus/add 1 hour a time. Keep pressing to accelerate the adjusting speed; Press Time key again, the minute position and “OFF” are flashing. The controller will judge the order of timer on and off and use the arrow to show the order. First ON then OFF: ON→OFF; First OFF then ON: ON←OFF. Press Set to confirm the setting. If there is no input for 10s, this setting will be cancelled and the timer will come back to the previous state.

Operation

Timer Setting Cancellation

(1) If there is no Time key related operation for 10s, this setting will be cancelled and the timer will come back to the previous state.

(2) Sequence: Pressing Time once, it displays default  8:00 for the first time (previous setting will be displayed if there is setting before). The hour position and "ON" are flashing;

Pressing for a 2nd time, the minute position and "ON" are flashing;

Press for a 3rd time, it displays default  12:00 for the first time (previous setting will be displayed if there is setting before). Then the hour position and "OFF" are flashing;

Pressing a 4th time, the minute position and "OFF" are flashing;

Pressing a 5th time, it displays default  8:00 for the first time (previous setting will be displayed if there is setting before). Then the hour position and "ON" are flashing;

Pressing a 6th time, the minute position and "ON" are flashing;

Pressing a 7th time, it displays default  12:00 for the first time (previous setting will be displayed if there is setting before). Then the hour position and "OFF" are flashing;

Operation

Pressing a 8th time, the minute position and “OFF” are flashing;

Pressing a 9th time, cancel the setting.

(3) Relation to other buttons when timer is set.

Press the Mode key or Fan key to exit the current setting, press them again to operate the function accordingly; Press the  (ON/OFF) key can exit the timer setting and power ON/OFF directly. If there is a timer before, the wired controller will operate by following the previous setting. If not, the wired controller will have no timer operation.

Swing

(1) If Sw5 is on, only the Up/Down swing will be involved in function circulation. At this time SW7 is invalid.

(2) If Sw5 is off, swing type can be set by Sw7, when Sw7 is off, only Up/Down swing valid, when Sw7 turns on, Up/Down and Left/ Right swing valid. Only Up/Down swing is default.

① If Sw7 is off (default): only Up/Down swing is available.

Press SET key to enter function circulation, Up/Down swing icon flashing, then press SET key again to confirm with swing icon statically displaying. If swing function is set, execute the above operation to cancel.

Operation

② If Sw7 is on: Up/Down swing and Left/Right swing are available.

Press SET key to enter function circulation, Left/Right swing icon flashing, then press Up/Down key to enter Up/Down swing, with Up/Down swing icon flashing. Press SET key again when swing icon flashing to confirm, with swing icon statically display. If swing function is set, execute the above operation to cancel.

③ If connecting to the slave wired controller, Sw7 dip code of master and slave wired controllers should be set the same and should match the actual wired controller unit.

(3) If Sw5 is off, some models can self-adaptive the swing setting and swing angle control.

Operation

① If the angle of the Up/Down swing can be adjusted:

Press SET key to enter the function circulation; the Up/Down swing icon will flash. Press the SET key again; the swing angle will flash(if powered on for the first time, default angle will be different according to different modes; if not for the first time, the angle of swing will be displayed as last time). At this time, swing angle can be adjusted by Up/Down key (when in intelligent mode, the swing angle is position 1,press up key to automatic swing, and press down key to position 2).When pressing Up/Down key to adjust angle, If no operation in 10s, it will exist angle adjustment and function circulation. Interface displays the last angle. If you want to set other functions like sleep function, you need to press SET key again to enter function circulation.

② If the angle of the Up/Down and Left/Right swing can be adjusted:

Press SET key to enter the function circulation, and the Left/Right swing icon will flash. At this time, press Up/Down key to switch to Up/Down swing icon flashing. When Left/Right swing icon flashing, Press SET key again, the angle of Left/Right swing will flash(if powered on for the first time, the default angle is in position 1, the middle position of Left/Right swing icon; if not for the first time, the angle will be displayed as last time).

Operation









(4) Pressing Fan key or Mode key can both exit swing function, with no order sending. When Fan or Mode key is pressed again, the order will be sent. If the present angle is confirmed, pressing SET key will exit the swing function. In the adjustment process, if there is no key pressed for 10s, swing function will be exited, and swing angle will execute the final adjusted angle. In the adjustment process, pressing the ON/OFF key to power off the wired controller directly, and swing angle is the final adjusted swing angle.

Operation

Health airflow up/down function (Only valid for part of models)

(1) The function can be set through wired controller or remote controller.

(2) The function circulation is as follows:

 (Only when Left/Right swing is valid) →  (Only when Up/Down swing is valid) →  →  (ventilation function) →  (reserved function) →  (When it's time for filter cleaning, this icon will involve in circulation) →  (the second 8 of 88.8 in the temp. display area displaying A, only valid for part of models) →  (the second 8 of 88.8 in the temp. display area displaying B, only valid for part of models) →  (motion sensing, only valid for part of models) → 10°C heating function (this function only works in the heating mode, only valid for part of models) → health airflow up (Only valid for part of models) → health airflow down (Only valid for part of models)

(3) The function is valid only when the angle of Up/Down swing can be set.

(4) Health airflow up/down function cannot be set at the same time. When the latter is set, the former will be automatically canceled.

(5) This function is ground floor setting, no matter on/off, memory remained.

Operation

(6) After the function is set, the angle of Up/Down or Left/Right swing can be normally adjusted in the main interface. Press the SET key to enter function circulation. When Up/Down swing icon flashes, press SET key, and then swing angle position 1 will flash. Press Up/Down key to adjust the angle. When the adjusted swing angle is executed, the health airflow up/down is canceled simultaneously.

Sleeping

(1) Press Set key to enter function setting, press ▼ ▲ to the sleeping icon “☺” and it will flash, the sleeping time will display by the  which is on the top-right corner. Press Time key to enter sleeping time setting. “OFF” and sleeping icon are flashing. Press ▼ ▲ to adjust the sleeping time by 0.5h once, the range of sleeping time is from 0.5h to 72h. After the adjustment, press Set key again to confirm the operation. “OFF” and sleeping icons are statically displayed.

(2) During sleeping icon is flashing, pressing Set key instead of Time key, the wired controller will take the converse operation of previous sleeping state. If there is sleeping set, cancel it; if not, come into the setting operation.

(3) If power off is executed during sleeping, the sleeping function is cancelled at the same time; there is no display when powered on again. It needs to be reset if any requirement.

Operation

(4) In sleeping set or modification state, if there is no operation in 10 seconds, it will keep previous state, and the setting or modification is invalid this time.

(5) Under sleeping and timer setting state, it will display setting time respectively; when setting simultaneously, it will display the prior executed time. When timer off is executed first, sleeping function will be cancelled and when sleeping is executed first, then timer off function will be operated after that.

(6) Under function setting state, it will exit function setting state by pressing Mode or Fan key.

(7) If set sleeping time to 1 hour, it will display 1.0h  on the interface.

(8) Sleeping time and timer on should not be set at the same time.

(9) When setting sleeping function, press ON/OFF key to quit sleeping set and turn off unit.

Operation

Heat Reclaim Ventilation Function

(1) Press **Set** key to enter function setting, press **▼▲** to the heat reclaim ventilation icon “” and it will flash, press **Set** key again to confirm the operation. The above operation can cancel the heat reclaim ventilation function if heat reclaim ventilation function has been set.

(2) After setting heat reclaim ventilation function, it is switched off together with off command from wired controller. Heat reclaim ventilation function is kept once the unit is switched on again.

(3) After you set heat reclaim ventilation function, change mode of wired controller, heat reclaim ventilation function is kept and heat reclaim ventilation function will be memorized when non-volatile memory valid.

Switch between Fahrenheit and Celsius

(1) If the current temperature is displayed in Celsius, set temp. should be adjusted to 30°C in each mode (when energy saving function is set currently, the heating mode will be the highest limit value of the energy saving function). Then press **▲** key for 15s to switch to Fahrenheit, the interface will display 86°F (when energy saving function is set, its highest limit value of Fahrenheit will be displayed).

Operation

(2) If the current temp. is displayed in Fahrenheit, set temp. should be adjusted to 60°F in each mode (when energy saving function is set currently, the cooling/dry mode will be the lowest limit value of the energy saving function). Then press ▼ key for 15s to switch to Celsius, the interface will display 16°C (when energy saving function is set, its lowest limit value of Celsius will be displayed).

Humidity Function (Only valid for part of models)

(1) Press the mode key to switch to the dry mode, and the humidity will be shown in the temp. display area. The Up/Down key is the humidity adjusting key.

(2) If Sw2 is set to be on, the temp. display area will display the ambient temp. in all modes except for the dry mode, which will display the ambient humidity. When in the state of OFF→ON, mode shift to dry mode, set humidity adjustment in dry mode, the set hum. will display statically, SET icon flashes and after 3s, ambient hum. and ROOM icon display statically.

Operation

Energy Saving

(1) Press **Set** key to enter function setting, then press ▼▲ to choose energy saving, press **Set** key again to confirm the operation and display energy saving icon **ECO** . If energy saving function has been set, the above operation will cancel it.

(2)The energy saving default parameter are 23°C (74°F) (the lowest temp. limit of cooling and dry mode) and 26°C (78°F) (the highest temp. limit of heating mode). The temp. adjusting range is 23°C-30°C (74°F-80°F) in cooling and dry mode, the temp. adjusting range is 16°C-26°C (60°F-78°F) in heating mode. If energy saving function is set, the indoor units will run at the default temperature.

Note: Fresh Air unit has no energy saving function.

Filter Cleaning

When filter cleaning icon  is displayed, the icon will display in function sequence. If filter cleaning icon is flashing, press **Set** key to clear it.

Operation

10°C Heating Function (Only valid for part of models)

(1) Only in heating mode, this function is valid in function circulation.

(2) For the four-way cassette model, press the SET key for 5s to enter the function circulation. When it switches to the 10°C heating function, 10°C will flash in the temp. display area. Press the SET key to confirm, and 10°C will be statically displayed.

(3) If the wired controller receives the signal of 10°C heating function sent by the remote controller, 10°C will be statically displayed in the temp. display area of the wired controller.

(4) If the wired controller is displaying room temp., when the 10°C heating function is set. The 10°C will be statically displayed for 3s, then it changes to display room temp.. If the temp. area displays room temp., press the Up/Down key first, the 10°C heating icon will be displayed. Press the Up/Down key again, exit the 10°C heating function. Meanwhile, the set temp. will be displayed statically, at this moment, the SET character flashes for 3s, then the room temp. and ROOM character displays. Press the mode key to change the mode directly, and at the same time exit the 10°C heating function; press the Fan key or Time key, the command will be executed; press the Set key and the Up/Down key to switch to the 10°C function, press the function key again, the function will be canceled.

Operation

- (5) If it's not the four-way cassette model, press the Set key once to enter the function circulation. When it switches to the 10°C heating function, the temp. display area will statically display 10°C. Then press the Set key to confirm. The exist operations will be the same as the four-way cassette model.
- (6) This function can be remembered when it is turned on/off.

Four-way cassette - Function (Only valid for part of models)

- (1) When it is powered on for the first time, four-way cassette icon and Up/Down swing will be displayed. The number 1,2,3,4 next to the swing referred to different wind deflectors will be displayed (if the wind deflector is on the position 1, the Up/Down swing will stay the angle set by the wind deflector position 1. Meanwhile the number 1 next to the Up/Down swing will be displayed. If it is selected as four sides controlled together, the number 1, 2, 3, 4 next to the Up/Down swing will be displayed at the same time). Set key now can only switch among four wind deflectors. Use Up/Down key to set the angle of the current wind deflector.

Operation

(2) The circulation of the wind deflector:

four-way cassette deflectors controlled together→four-way cassette deflector 1→four-way cassette deflector 2→four-way cassette deflector 3→four-way cassette deflector 4→four-way cassette deflectors controlled together.

(3) If it's not the first time to enter it, press Set key, the wind deflector set last time will flash. Meanwhile the angle of this deflector set last time will be displayed statically, and the number of the wind deflectors next to Up/Down swing will be statically displayed.

(4) Press Set key to choose the wind deflector, and the selected one will flash. At this time press Up/Down key to adjust the angle of the wind deflector. The wind deflector will keep flashing when adjusting. After finishing adjusting for 5s, the wind deflector will be displayed statically, meaning existing the angle adjustment. At this time press Up/Down key to adjust the temp.. Pressing mode key or Fan key during the adjustment will exist the adjustment of four-way cassette function. The position and angle of the wind deflector will be set the same as last time. If no pressing Up/Down key for 5s after Set key pressed, the selected wind deflector will stop flashing and go back to the previous state.

Operation

Motion sensing (Only valid for part of models)

(1) Press Set key for 5s to enter the function circulation, and then press Up/Down key to switch to A (the second 8 of 88.8 in the temp. display area displaying A) \rightarrow B (the second 8 of 88.8 in the temp. display area displaying B) \rightarrow A (motion sensing).

(2) ① After motion sensing A is set, the character A will disappear with room temp./set temp. displaying. The icon of motion sensing will display statically.

② After motion sensing B is set, the character B will disappear, with room temp./set temp. displayed. The icon of motion sensing will flash in the fixed frequency.

③ After motion sensing is set, the icon of motion sensing will be displayed for 2s and disappear for another 2s to have respiratory effect.

Operation

Mode Setting (Only valid for part of models)

(1) In off and non screen saving state, press Mode key for 5s, it will display 8 segment on the top-left corner of current mode circulation, default value being 0. Press Up/Down key to shift between 0, 1, 2, 3, then press Set key to confirm value. It will follow the altered mode circulation after turning on the unit again.

Corresponding mode of different value.

0-----[Intelligent] [Heating] [Dry] [Cooling] [Fan]

1-----[Heating] [Dry] [Cooling] [Fan]

2-----[Dry] [Cooling] [Fan]

3-----[Heating] [Dry] [Cooling] [Fan]

(2) If modes are reduced and the mode that is set before turning off is not in the newly set mode circulation, the initial mode is fan.

(3) The intersection of mode circulation set by wired controller and indoor unit is valid.

(4) Fresh Air unit can execute mode setting, it will execute the intersection with three modes of Fresh Air unit (cooling/heating/fan mode)

(5) This setting is ground floor setting and will be memorized whether non-volatile memory invalid or valid.

Operation

(6) The mode of indoor units can be inquired /changed by the advanced setting function after the wired controller is powered on, Only valid for part of models.

(7) Set as follows (Only valid for part of models):

Press Set key and Up key for 5s to enter the advanced setting state, with the function A in temp. display area displayed statically. Press Fan key to switch to function B. The function code 01 displayed in the clock display area will flash. The specific information in the timing display area is statically displayed, it can be changed in the range of 00-03 by Up/Down key. At this time press Set key to confirm, and the function code 01 in clock display area stays static, the specific information in the timing display area flashes, meaning it can be changed currently. Press Up/Down key to change the content and Set key to confirm.

(8) If the mode is changed from more to less, the current mode will not be in the mode of the present circulation. It will be the fan mode after turn on.

Operation

Malfunction Display

- (1) The main interface does not display malfunction.
- (2) Under no screen saving state, press Time key for 10 seconds to check all indoor units malfunction in the group, but at this time, the interface does not display clock information and timer information. Unit No. is displayed behind the top-left colon; current malfunction is displayed before top-right colon and historical malfunction is behind colon.
- (3) Unit No. is displayed in decimal and malfunction is displayed in hexadecimal.
- (4) All hexadecimal numbers of malfunction are in capital. But b and d is in small capital in order not to mix with 8.
- (5) If there is no current malfunction, "--" is displayed before the right colon; if there is no historical malfunction, "--" is displayed behind the right colon.
- (6) Press Time key to quit malfunction check state. The clock information and timer information are displayed.
- (7) Malfunction records clearance: Keep pressing Time key for 10 seconds, malfunction is displayed. Then press Time key again for 5 seconds to clear current and historical malfunction of all the units.
- (8) Press ▼ ▲ to choose unit No..

Operation

Child Lock

(1) Child lock function can be used to prevent false operation. All of keys are locked after pressing **Set** and **▼** together for 5 seconds. child lock icon  will display on the interface. All of settings will exit and keep the previous state. All of keys are invalid including "ON/OFF".

(2) The screen will unlock after pressing **Set** and **▼** together for 5 seconds, child lock icon will disappear and all keys are available.

Note:

When controlling Fresh Air unit, the controller main interface will not display Up/Down key in normal state. When in child lock setting, press Time key first to display Up/Down key at the main interface, and then press **Set** and **Down** key together for 5 seconds to enter child lock setting. After setting child lock, Up/Down key will keep displaying for the convenience of cancellation of child lock.

Operation

Parameter Inquiry

(1) Keep pressing **Set** for 5 seconds (if it is the four-way cassette model, the time is 10 seconds) to enter parameter inquiry. Unit No. is displayed on 88 area of clock while data type is displayed on 88 area of timer. Unit No. is displayed on the first two "88" fields of clock while data type is displayed on the first two "88" fields of timer. The data type includes A, b, C, d, E and F. The current data is displayed behind date type. For example, ambient temp. of 00 unit is 16 degree, then "00 A 16" is displayed. Press ▼▲ to choose different type of data from A, b, C, d, E and F.

Data	Type meaning	System
A	Indoor sensor Tai temp.	Actual value, decimal sys.
b	Indoor sensor Tc1 temp.	Actual value, decimal sys.
C	Indoor sensor Tc2 temp.	Actual value, decimal sys.
d	Indoor unit PMV opening/2	Actual value, decimal sys.
E	Indoor unit address	Actual value, hexadecimal sys.
F	Indoor unit central address	Actual value, hexadecimal sys.

Operation

- (2) In parameter inquiry state, press Time key to change the unit No. address in the group.
- (3) In parameter inquiry state, press the Set key again or have no operation for 10 seconds to exit.
- (4) In parameter inquiry state, press Mode or Fan can exit the parameter inquiry and press above keys again, their corresponding functions will work.
- (5) In parameter inquiry state, press "ON/OFF" , it will exit the current state directly and then turn on/off.

Operation

Unit No. Setting

- (1) Entering: Press **Set** key for 10 seconds (if it is the four-way cassette model, the time is 15 seconds) to enter unit No. setting/ inquiring.
- (2) Setting is available when the communication address between indoor and outdoor unit is flashing if the indoor unit's dip switch can set the address, then use **▼▲** to adjust within the range of 0-3F. If the indoor dip switch cannot set the address, the communication address between indoor and outdoor unit is static, which can only be inquired.
- (3) Wired controller's address is displayed before the colon of clock on the top-left corner, ranging from 0 to 15 and displayed in decimal system.
- (4) The communication address between indoor and outdoor unit is displayed on the top-left corner. The default value is the current unit's address, selecting other indoor units by the **▼▲**.
- (5) Central address is displayed on top-right corner which cannot be edited.
- (6) Press **Set** key to confirm and exit the setting after changing the communication address of indoor unit. If press other keys or no operation in 10 seconds, it will automatically exit and keep previous setting. If press **Mode** or **Fan** key, exit and the current setting is invalid. If press "ON/OFF", turn on/off the unit directly and the current setting is invalid.

Operation

Static Pressure Grade Inquiry and Adjustment Function

- (1) In the state of ON and non screen saving state, press Fan + Set keys for 5s to enter static pressure grade adjustment state with static pressure icon flashing and current static pressure grade statically displaying. Press ▼ ▲ key to change static pressure grade, then press Set key to confirm.
- (2) The unit No. will display by two 8 segments after colon on the top-left corner, and static pressure grade will display by two 8 segments after colon on the top-right corner. Press Time key to shift unit No..
- (3) Unit No. will show decimally from 00-15. Static pressure will be shown decimally from 01-04.
- (4) In query and adjustment state, if there is no screen saving, press ON/OFF key to quit current state and turning on/off unit, with changed values not being saved.
- (5) Static pressure is the inquired value with non-volatile memory invalid.
- (6) The slave controller can't set the static pressure grade.
- (7) The number about the indoor units' static pressure grade and the static pressure grade executed by the indoor units can be queried/ changed by the wired controller(Only valid for part of models).

Operation

(8) The number about the static pressure grade and the static pressure grade can also be queried/ changed by advanced setting interface(Only valid for part of models).

Rated Operation Function (Only valid for part of models)

(1) Press the SET key and ▲ key for 5s to enter the advanced setting interface to inquire/adjust rated operation function. Function A will be displayed in the temp. display area. The last two 88 in the clock display area show the function code, and the timing display area shows the specific information of the current function.



(2) After entering the advanced setting, function A in the temp. display area stays statically, and it can be changed by the Fan key. The function code 01 displayed in the clock display area flashes, which can be changed by the Up/Down key. The specific information in the timing display area stays statically. At this time press SET key to confirm. The function code 01 in the clock display area stays statically with the specific information flashes in the timing display area, meaning the specific information can be changed currently, press the Up/Down key to change the content and the SET key to confirm.

Operation

- (3) Rated operation including USA rated operation and European rated operation can be inquired/adjusted through function code 07 in the advanced setting. “00” means the European rated operation, and “01” means the USA rated operation.
- (4) If the content of 07 is “00”, then press the Up/Down key to switch to 08(Europe rated operation) directly, “09” will not in the function code cycle, use the Up/Down key to adjust and press the SET key to confirm .
- (5) If the content of 07 is “01”, press the Up/Down key to switch to 09(USA rated operation) directly. “08” will not in the function code cycle. use the Up/Down key to adjust, and press the SET key to confirm.
- (6) When in the Europe rated operation situation, only rated cooling condition(00-05) can be set in cooling mode; only rated heating condition(00-04,06,07) can be set in heating mode. In other modes, rated condition can't be set.
- (7) When in the USA rated operation situation, only rated cooling condition(00-05)can be set in cooling mode; only rated heating condition(00,06-11) can be set in heating mode. In other modes, rated condition can't be set.
- (8) If the wired controller sets the rated operation function, only wired controller can cancel it. If the remote controller sets the rated operation function, the wired controller and remote controller can both cancel it.

Operation

Communication with Central Controller

- (1) The controller displays  to show central control mode after receiving central control signal from indoor unit;
- (2) When  statically displays, all keys except “ON/OFF” of wired controller are invalid. central icon will disappear if no central control signal from indoor unit.
- (3) When receiving locking signal from indoor unit,  statically display, all keys are invalid.
- (4) In central or lock state, screen saving is valid; press any key to wake up screen.
- (5) In central or lock state, malfunction inquiry, indoor unit parameter inquiry and child lock are valid.

Energy Saving Parameter Setting

- (1) Under cooling mode 30°C (86°F), keep pressing Fan key for 5 seconds to set energy saving parameter in cooling mode. This cooling energy saving parameter is flashing behind top-left colon. The default value is 23°C (74°F). This lowest target cooling temperature can be adjusted by ▼▲. After setting, press Set key to confirm and exit.

Operation

- 2) Under heating mode 16°C (60°F), keep pressing Fan key for 5 seconds to set energy saving parameter in heating mode. This heating energy saving parameter is flashing behind top-right colon. The default value is 26°C (78°F). This highest target heating temperature can be adjusted by ▼▲. After setting, press Set key to confirm and exit.
- 3) Energy saving parameter will be valid after energy saving icon ECO displays.

Non-volatile Memory

- (1) Set valid or invalid non-volatile memory through dip switch Sw4.
- (2) Info memorized: Mode, Fan Speed, Temp. Setting, Swing State, Heat Reclaim Ventilation function.
- (3) If timer or sleeping is set, it will be in OFF state after electrified again; it will memorize all the state before power failure except ON/OFF state.
- (4) For easy maintenance, no matter non-volatile memory is valid or invalid, malfunction record will be remembered.

Operation

Communication Malfunction of Wired Controller

If there is no communication between wired controller and indoor unit for 4 minutes, it will display error code “07” when checking malfunction.

Sensor Malfunction

If the dip switch is set to collect ambient Temp. from wired controller and the sensor can't work normally, it will display error code “01” when checking malfunction.

Temp. Compensation Setting

- (1) In OFF state, keep pressing F an key for 5 seconds, the current temp. compensation value is displayed on the top-right of the screen and flashes. “00” is the default value.
- (2) When in celsius system, ambient compensation value is -04~+04°C, while in fahrenheit system, ambient compensation value being -07~+07°F. The temp. compensation value can be adjusted by pressing ▼▲ .
- (3) After adjustment, press Set key to confirm the setting.
- (4) The compensation value is used for ambient temp..
- (5) The compensation value is valid only in the state of collecting ambient temp. of wired controller.

Operation

Forced Cooling/ Heating

(1) Powered off in cooling mode, keep pressing “ON/OFF” key for 10 seconds, it will enter into the forced cooling function, and the cooling mode icon will be displayed on the interface.

“LL” is flashing in the temp. area at the same time. Press “ON/OFF” key to power off and exit forced cooling.

(2) Powered off in heating mode, keep pressing “ON/OFF” key for 10 seconds, it will enter into the forced heating function, and the heating mode icon will be displayed on the interface,

“HH” is flashing in the temp. area at the same time. Press “ON/OFF” key to power off and exit forced heating.

(3) All the keys are invalid except “ON/OFF” key under forced cooling/heating mode, which can be cancelled by powering off manually or receiving “trial operation” finished order from the communication. The former one can operate power off directly while the later one will make the controller do by following the order.

Wired Controller Wiring Instruction

Wiring Connections of Wire Controller

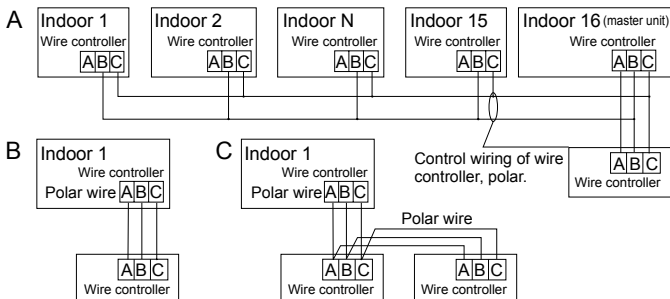

There are three methods to connect wired controller with the indoor units

- One wired controller can control max. up to 16 sets of indoor units, and 3 pieces of polar wire must connect the wire controller and the master unit (the indoor unit connected with wire controller directly), the others connect with the master unit through 2 pieces of polar wire.
- One wire controller controls one indoor unit, and the indoor unit connects with the wire controller through 3 pieces of polar wire.

Wired Controller Wiring Instruction

C. Two wired controllers control one indoor unit. The wired controller connected with indoor unit is called master one, the other is called slave one. Master wired controller and indoor unit; master and slave wire controllers are all connected through 3 pieces of polar wire.

Communication wiring

Communication wiring length (m/ ft)	Dimensions of wiring
< 100m/328ft	0.3mm ² x3-core shielded wire (22AWG,3wire)
≥100m/328ft and <200m/656ft	0.5mm ² x3-core shielded wire (20AWG,3wire)
≥200m/656ft and <300m/984ft	0.75mm ² x3-core shielded wire (18AWG,3wire)
≥300m/984ft and <400m/1312ft	1.25mm ² x3-core shielded wire (16AWG,3wire)
≥400m/1312ft and <500m/1640ft	2mm ² x3-core shielded wire (14AWG,3wire)

*One side of the shielded sheet of communication wire must be earthed.

Wired Controller Wiring Instruction

1. First, put communication wire through the hole in the back cover.

Press this button to open the back cover of the wired controller.

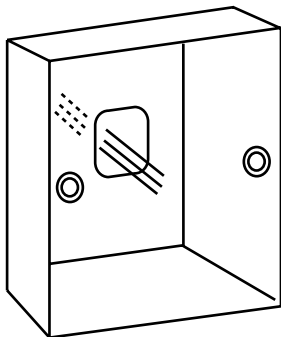
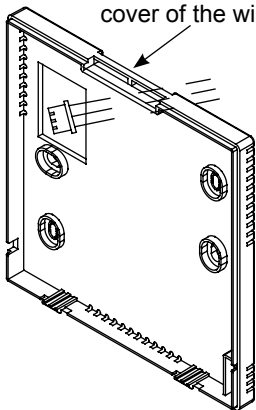

2. Fix back cover to the holder. After that, connect communication wire to CON1 port of wired controller. Finally put the front cover of wired controller to back cover to complete the installation.

Wired Controller Wiring Instruction

